

ATLAS STONE - STACKED INSTALLATION GUIDE



COMPOSITE STONE PANELS BY ROYAL®

GENERAL INFORMATION

CAUTION: REMEMBER THAT POLYMERS UNDERGO EXPANSION AND CONTRACTION WITH VARIATIONS OF TEMPERATURE. THE FOLLOWING INSTRUCTIONS WILL ALLOW FOR THIS EXPANSION AND CONTRACTION OF THE MATERIAL

1-Always begin the installation from left to right at the lowest part of the structure.

2-Always fasten through the center of the installation holes. Each complete panel must be fastened through the center hole, at both extremities and have a minimum of 7 fasteners in the nailing channel at maximal spacing of 8"(20.32cm) or less and one fastener into the lateral hole (Figure 1). If panels are installed on a wall with furrings, furring strips should be installed on a 45° angle, at 8"(20.32cm) center to center and a furring strip is required behind each fastener.

3-Never hammer or screw the fasteners in completely; leave a gap of 1/16"(0.16cm) between the nailing channel and the fastener's head (Figure 2). Always use non-corrosive nails or screws with a head of 0.4"(1cm) in diameter and a body of 0.150"(0.38cm) in diameter and penetrate through the solid surface by at least 1 1/4"(3.18cm) and into a solid substrate by at least 7/16"(1.11cm).

4-Make sure that all pieces are properly joined together (two side locks and 9 hooks at the bottom of the section). (Figure 3)

5-When using a finish trim (J-channel, Outside Corner Post, etc.), leave a space of 1/4"(0.64cm) between the trim and the siding (Figure 4). The required opening for finish trim is 1 1/8"(2.86cm).

Note:

To cut the material, it is recommended to use a circular saw with a finishing blade. Keep the R-E-L number of your products (ex: REL-123456) for future reference and any warranty issues.

Figure 1

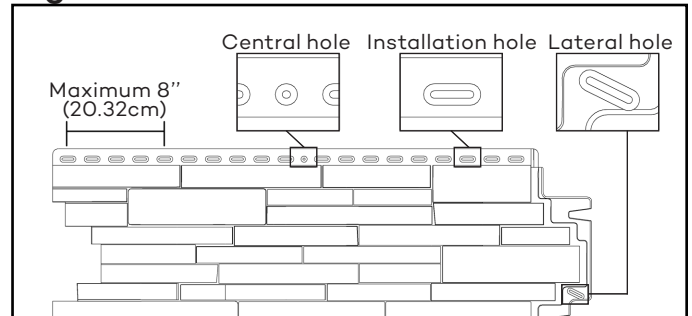

Figure 2

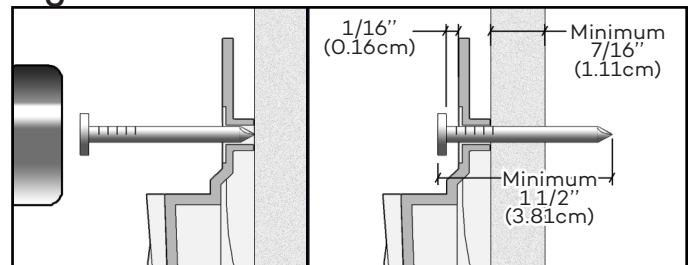

Figure 3

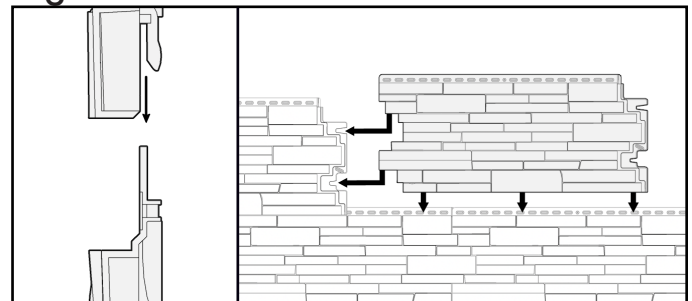
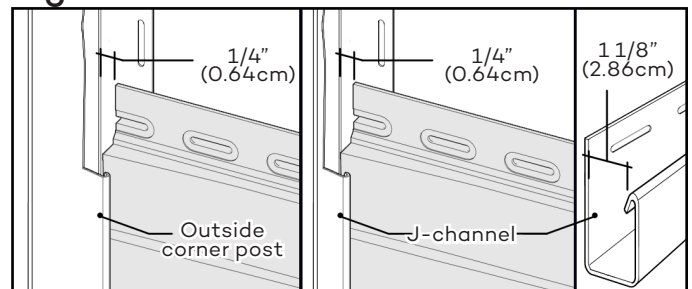

Figure 4



Some elements of the image above were partly removed to facilitate understanding.

ATLAS STONE - STACKED INSTALLATION GUIDE



COMPOSITE STONE PANELS BY ROYAL®

INSTALLATION STEPS

1-First install the starter strips at the lowest point of the structure. Make sure that the horizontal starting line is perfectly leveled and square with the wall. Leave a 3 1/2" (8.89cm) gap at each end of the wall for corner posts, corners or J-channels (1). If a floor is against the wall, install the top of the starter strips at 2 1/8" (5.40cm) above it in order to leave a gap of 1/4" (0.64cm) between starter strips and the floor (2). If there is no floor, starter strips should be flush with the base of the wall. Fasten the starter strips at maximum spacing of 8" (20.32cm) or less. Install the next starter strip by pressing it against the previous (3) and fasten as mentioned above (Figure A). Be sure to align adjacent walls.

2-Determine the number of panels needed for the wall by dividing the total length of the wall, less the width of the corner pieces used, by 39 1/2" (100.33cm). Cut the left side of the first panel in a straight line in order to avoid having a very small piece at the right end of the wall. Any installed panels should be at least 12" (30.48cm) long. Insert the first panel onto the starter strip and slide it leftward leaving a 2 1/2" (6.35cm) space between its edge and the wall corner (Decorative corners will be installed after. See corners installation instruction section for detail.) or slide panel into the trim leaving a space of 1/4" (0.64cm) between the inside wall of the trim and the panel (Figure B).

3-On each panel, fasten the center hole of the product, this will ensure even movement of panels in both directions during expansion/contraction. Also place a fastener into the last hole on both ends, plus 2 others evenly spaced on each side of the center hole of the nailing channel (Figure C). Fasteners should never be spaced more than 8" (20.32cm). Each full length panel should be secured with a minimum of 7 fasteners in the nailing channel and one fastener into the lateral hole. Remember that fasteners must be placed in the center of the installation holes. Always use non-corrosive fasteners penetrating into a solid substrate of no less than 7/16" (1.11cm) thick. When attaching the fasteners, be sure they only lightly touch the product allowing it to move with varying temperatures and they are installed flush with the panel, so as not to interfere with the succeeding row.

- If product is installed on a furring wall, a furring strip is required behind each fastener.

- If a panel does not have the initial center hole, drill a new center hole of 1/8" (0.32cm) diameter at the same height as the other installation holes.

Figure A

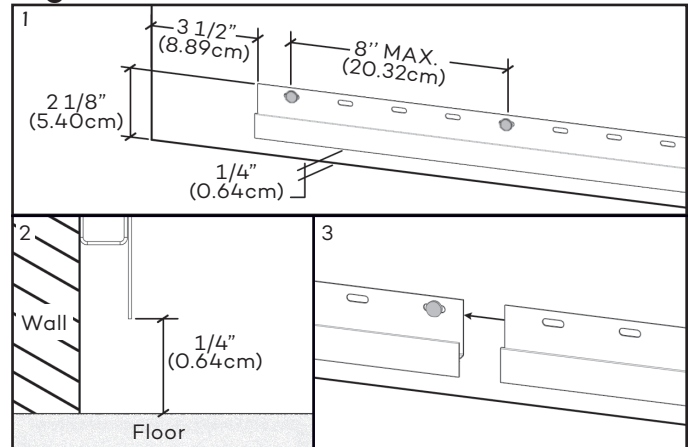

Figure B

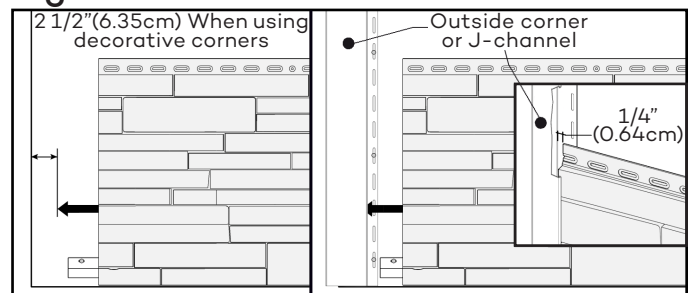
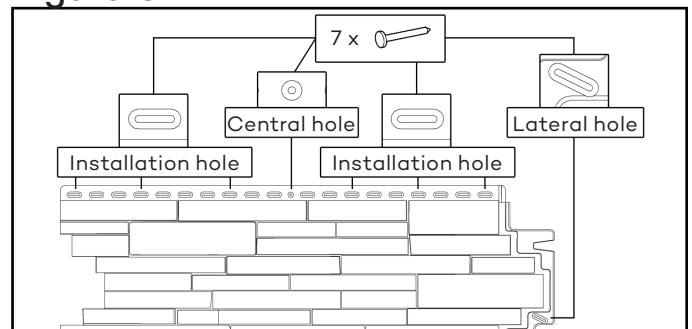

Figure C



ATLAS STONE - STACKED INSTALLATION GUIDE



COMPOSITE STONE PANELS BY ROYAL

INSTALLATION STEPS (CONTINUATION)

4-Install the following panel by hooking it onto the starter strip and sliding it to the left inserting the two side locks into the previous. Space the panels equally according to the outdoor temperature during the installation. If product is installed in an outdoor temperature from 30°F to 100°F (-1°C to 38°C) position the next panel so that its upper left edge butts up against the previous panel nail hem. For installations below 30°F(-1°C), position the panel slightly right of the previous panel (1/16"(0.16cm)) (Figure D). Once the panel has been properly spaced, fasten it as previously indicated. Repeat this step until the end of the row.

Figure D

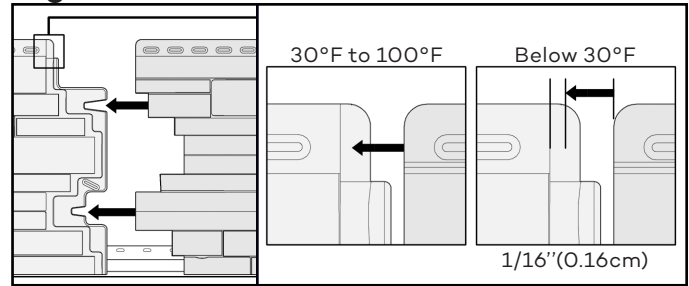

5-Begin the second row by cutting the first panel with approximately 8"(20.32cm) increment from the cutting line of the first row. Hooking the panel onto the top of previous row. Never force panels down on top of each other or into each other, left to right, or else risk breaking the stop posts on the back of the product. Set them into place gently, ensuring that all fingers and/or side locks are engaged, and allow the panels to seat themselves. The stop posts are designed to prevent buckling due to changing temperatures. In order to achieve a realistic look, alternate the cut position of each subsequent course in increments of 8"(20.32cm) (Figure E).

Figure E

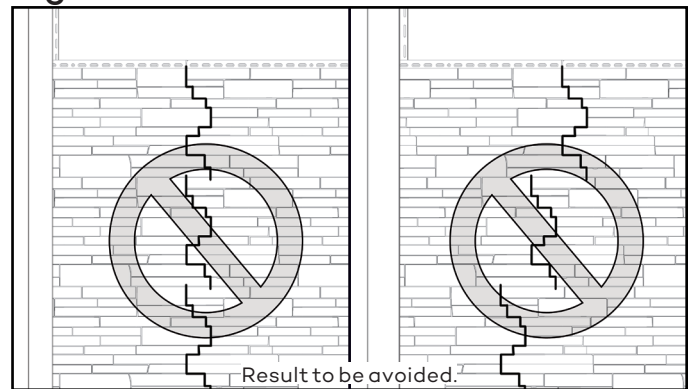

6-For the last row or places where you may need to attach product other than in installation holes, use a knife to create a new 1"(2.54cm) slot (Figure F); the slot must be wider than the fastener but not as wide as the fastener head. Although not set in installation holes, this type of cutting will allow the expansion/contraction movement of panels.

Figure F

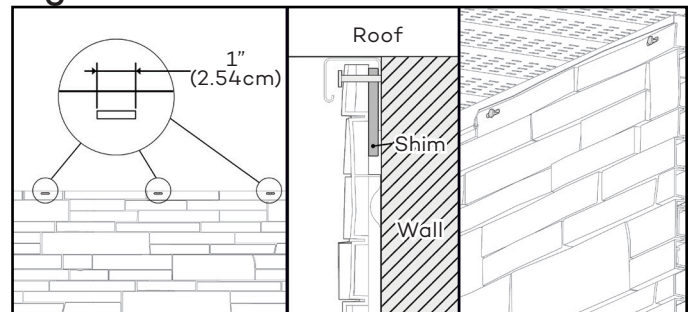

Some elements of the image above were partly removed to facilitate understanding.

-Note: For proper installation & optimal appearance, shim as required to adjust the angle of the last row.

Reminder: Do not set accessories directly on the product. The fasteners must be fixed into a solid surface. If you need to set accessories over siding, at a concealed spot on the product create a new 1"(2,54cm) slot larger than the fastener body but smaller than the fastener head to permit expansion/contraction of panels.

SPECIAL SITUATIONS AND SUGGESTIONS

SITUATION:	ITEMS TO CHECK:
- Panels won't lock together side to side.	The wall may not be level and flat. Check previous panels to ensure that all panels and installation fingers are properly seated. (See General Information) Use shims as needed to ensure a level wall surface.
- The bottom locking fingers won't lock onto the previous row.	
- Panels are buckling on the wall.	Make sure the fasteners are not restricting product movement. Check for proper spacing at side interlocks. Make sure all fingers are properly engaged into previous panel.
- Panels are not laying flat against the wall.	

ATLAS STONE - STACKED INSTALLATION GUIDE



COMPOSITE STONE PANELS BY ROYAL®

DECORATIVE CORNERS INSTALLATION

Caution: Product must be installed on adjacent walls prior to installation of the corners and be sure that rows are aligned.

1-When using the Atlas Stone Stacked corner, install a starter clip, open end up and 1/4" (0.64cm) higher than the top of the starter strips. Be sure to leave a 11/32" (0.87cm) space between the bottom of the starter clip and the floor (Figure G).

2-Slide the first corner over the panels and engage it into the starter clip (#1, Figure H). Once positioned properly, insert one fastener on each side of the nailing head. Galvanized screws are recommended as fasteners.

3-Install another corner over the panels and engage it into the corner below (#2, Figure H). Some adjustment may need to be made at the vertical overlap of two corners (as they are installed) in order to maintain the corner/panel horizontal alignment. There is approximately a 1/2" (1.27cm) vertical adjustment available. Gently tug the bottom of the corner to ensure it is properly engaged and fasten it. Repeat this step until the last corner installation.

4-For the last corner only, cut excess from part. On each side of the corner, make a hole wider than the shaft of the fastener, but smaller than the head. Affix a nailing strip behind these locations and install the cut part on the wall and fasten it on each side (Figure I).

Figure G

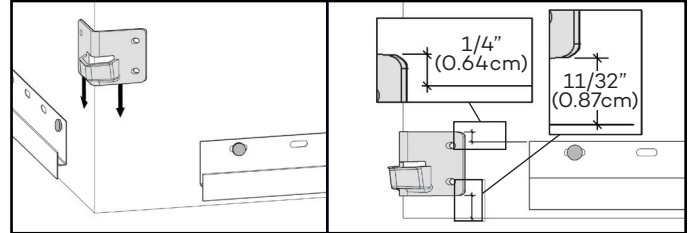

Figure H

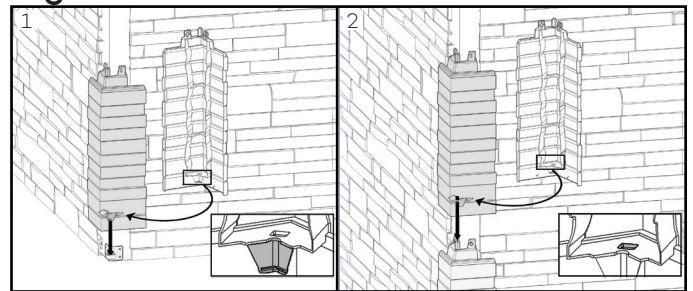
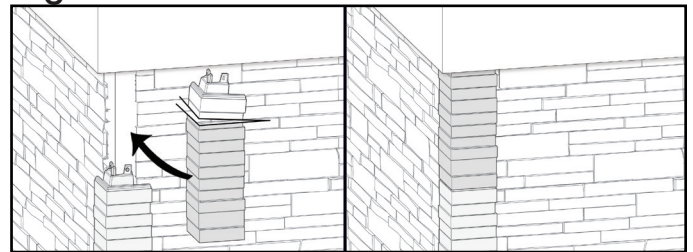

Figure I



INSTALLATION TIP

1-Many solutions are possible to finish an inside corner: Inside Corner Post (A) or two J-channels (B) (Figure J). It is important to seal the inside corner of the wall prior to installation of the trim.

Figure J

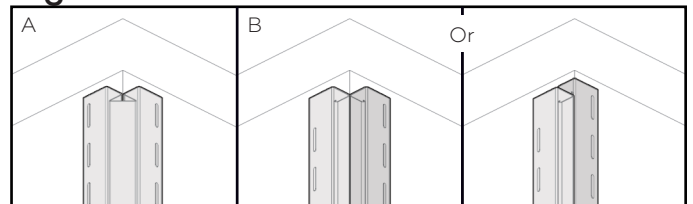

For details, see the respective installation guide of each product.